

# A review on recent applications of brushless DC electric machines and their potential in energy saving

## Authors

Mehdi Shirani<sup>a\*</sup>  
 Abbass Aghajani<sup>a</sup>  
 Saeed Shabani<sup>a</sup>  
 Jalil Jamali<sup>b</sup>

<sup>a</sup>Subsea R&D institute, Isfahan University of Technology, Isfahan, Iran

<sup>b</sup>Shoushtar branch Azad University, Shooshtar, Khuzestan, Iran

## Article history:

Received : 12 December 2014

Accepted : 25 April 2015

## ABSTRACT

*Electric motors are the largest consumer of world electric energy, consuming more than twice as much as lighting, the next largest consumer. Electric motors account for between 43 and 46% of all global electricity consumption approximately. They give rise to about 6 040 Mt of CO<sub>2</sub> emissions. End-users approximately spend USD 565 billion per year on electricity [1]. In recent years, increase in energy price has led to development of highly efficient motor technologies and their applications. Despite the fact that the application of brushless DC electric machines with variable frequency drive is rapidly increasing due to their higher efficiency versus typical AC motors, industries are not fully aware of the potential benefits of these machines and their applications. In this paper, recent applications of brushless DC machines in oil & gas, transportation, home appliance, HVAC and refrigeration, marine propulsion and electricity production and their potential energy saving are reviewed.*

**Keywords:** Electric Machine, Brushless DC, Efficiency, CO<sub>2</sub> Emission, Home Appliance, Oil & Gas.

## 1. Introduction

An electrical machine that converts electrical energy into mechanical energy is called an electric motor. An electric generator converts mechanical energy into electrical energy. The interaction between winding currents and electric motor's magnetic field generates force within the motor. Electric motors can be powered by alternating current (AC) or by direct current (DC) sources. Electric motors output power ranges from a few watts to hundreds of kilowatts. Electric motors are classified according to the type of power they supply and other criteria [2]. Figure 1 shows a classification of electric motors.

If a current carrying conductor is placed

inside a magnetic field, that conductor will experience mechanical force. This is the basic working principle of a DC motor. In a DC motor, an armature rotates inside a magnetic field, (Fig. 2). To build a DC motor, it is necessary to establish a magnetic field. The magnetic field is created by means of magnets. Any type of magnet can be used to create the magnetic field, *i.e.* it can be permanent magnet or electromagnets. A motor is referred to as permanent magnet DC motor or PMDC motor when permanent magnet is used to establish the magnetic field in a DC motor. Permanent Magnet motors are essentially simple to construct.

The field poles of a permanent magnet DC motor are made of permanent magnet. A PMDC motor principally includes two parts: A stator and an armature. The stator is a steel cylinder and the magnets are installed in the

\*Corresponding author: Mehdi Shirani  
 Address : Assistant Professor, Subsea R&D institute,  
 Isfahan University of Technology, Isfahan, Iran  
 E-mail address: mehdi.shirani@cc.iut.ac.ir

the inner periphery of this cylinder. The North (N) Pole and South (S) Pole of each magnet are alternatively faced towards the armature as shown in Fig.3.

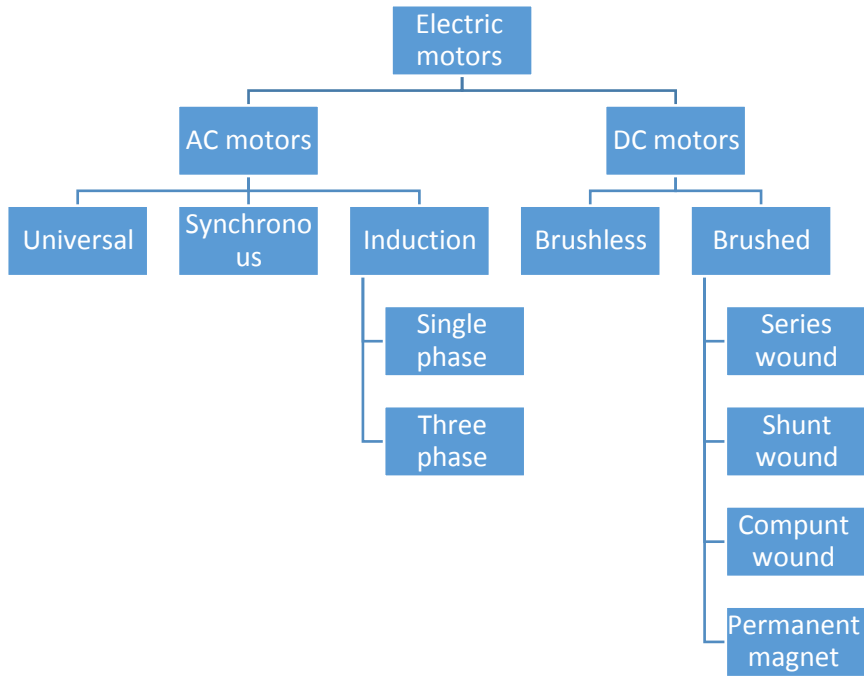

Fig. 1. A classification of electric motors

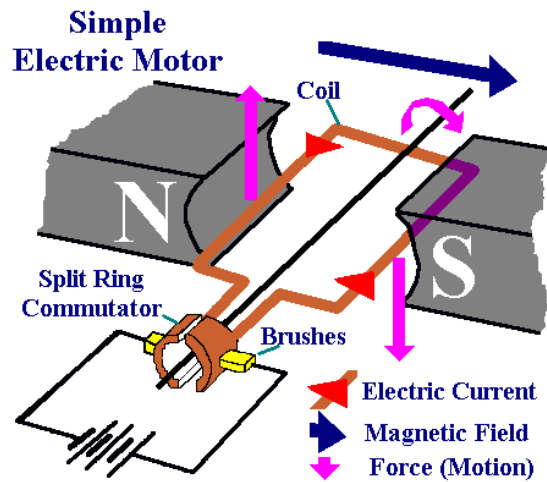

Fig. 2. A brushed electric motor with a two-pole rotor and PM stator [3]

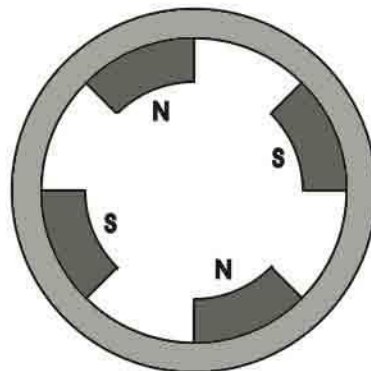

Fig. 3. Stator of Permanent Magnet DC Motor [4]

The rotor of PMDC motor is the same as in other DC motors. It consists of a core, windings and commutator. A number of varnish insulated, slotted circular lamination of steel sheets form the rotor core. The armature conductors are placed inside slots on the outer periphery of the armature core. The end terminals of the winding are joined to the commutator segments placed on the motor shaft. To supply current to the armature, Graphite or Carbon brushes are placed with spring pressure on the commutator segments.

As mentioned above, when a current carrying conductor enters a magnetic field, a mechanical force will be experienced by the conductor. As in a permanent magnet DC motor, when the armature is placed inside the magnetic field of a permanent magnet; the armature starts to rotate.

Slip rings and brushes are sources of unreliability and require maintenance. This shortcoming can be solved by the use of brushless DC motors. A brushless electric motor is an electric motor which lacks any form of commutator or slip ring. Depending on their design, they can be driven by either alternating current (AC) or direct current (DC).

Brushed DC motors have been in commercial use since 1886 [5]. Brushless motors, on the other hand, did not become commercially viable until 1962 [6]. A brushless DC electric motor contains a synchronous motor and integrated power electronics.

In brushless motors, difficulties related to connecting current to the rotating armature are eliminated by permanent magnets which rotate around a fixed armature and an electronic controller is replaced with the brush/commutator assembly of the brushed DC motor. Electronic controller continuously switches the phase to the windings and keeps the motor turning. Rather than the brush/commutator system, the controller performs similar timed power distribution by using a solid-state circuit.

Brushless motors offer several advantages over brushed DC motors [7-9], including:

- No gearbox is needed

In brushless DC machines, machine torque is constant and there is maximum efficiency in the design speed range, therefore no gearbox is needed.

- Increased reliability and longer lifetime
  - Slip rings and brushes are subjected to wear and are source of unreliability in brushed DC motors. Eliminating

these components increases the reliability of the motor.

- Removing field excitation arrangement decreases the complexity of the system and increases the reliability. With no windings on the rotor, they are not subjected to centrifugal forces.
- Gearbox is subjected to fatigue and is a source of unreliability, repair and maintenance. Removing gearbox increases the reliability.

- Increased efficiency

Brushless motors are more efficient than brushed motors:

- The velocity of brushless motor is determined by the frequency at which the electricity is switched, not the voltage.
- Absence of brushes reduces mechanical energy loss due to friction.
- Eliminating gearbox decreases mechanical energy loss.
- No input power is consumed for excitation; this improves the efficiency of the motor.

- More torque per weight

No field coil is used in brushless DC motors and therefore space for field coil is saved which reduces the overall size of the motor.

- Reduced noise
- Elimination of ionizing sparks from the commutator
- Reduction of electromagnetic interference (EMI).
- Better cooling

The windings are supported by the housing; therefore they can be cooled by conduction, requiring no airflow inside the motor for cooling. This means that the motor's internals can be completely enclosed and protected from dirt or other foreign matter.

- Commutation with electronics instead of brushes allows for greater flexibility and capabilities not available with brushed DC motors.

The maximum power that can be applied to a brushless motor is limited by heat; too much heat weakens the magnets and may damage the winding's insulation.

Depending on the arrangement of components, configurations for the brushless DC motors are either axial flux, radial flux, transverse flux, or flux switching, with each topology having different tradeoffs among size, weight, efficiency and operating speed.

### Radial Flux Configuration

The radial flux configuration is the most widely used configuration in electrical machinery (Fig. 4).

### Axial Flux Configuration

Commercial units with this configuration were found only in specialized applications, such as industrial servomotors and computer disk drives (Fig. 4).

### Transverse flux configuration

The transversal flux machine is a relatively new and highly innovative concept. This configuration does not have major industrial applications.

The main requirements and environments in which manufacturers use brushless type DC motors include maintenance free operation, high speeds and operation where sparking is hazardous (i.e. explosive environments) or could affect electronically sensitive equipment.

The main application for permanent magnet motors is in variable speed drives where the stator is supplied from a variable-frequency, variable-voltage, electronically controlled source.

## 2. Recent applications of brushless DC motors

Many functions basically done by brushed DC motors can be fulfilled by brushless motors but control complexity and cost restricts brushless motors from completely replacing brushed motors. Brushless motors are

gradually dominating many functions in oil, gas, transportation, home appliance, HVAC, Marine propulsion and energy production industries.

### 2.1. Oil and gas industry

#### 2.1.1. Electric drive for compressors

Large pumps and compressors are the heart of the oil and gas industry. Compressors are found in variety of applications in refineries and petrochemical plants, gas pipeline boosting stations and refrigeration trains at liquefied natural gas (LNG) plants.

In the past, large compression systems used steam turbines or reciprocating engines as the prime movers. Today with the advent of gas turbines with power ranges of 10 – 100 MW, large compressors generally use gas turbines as the prime mover. Gas turbines operate at high speed and have the advantage of using natural gas for fuel that is usually available at the site. Electric helper motors have been used to start the turbine and to provide additional power when needed.

Designs of Variable Frequency Drive in the late 1990's made it possible to use electric motors up to 100 MW. Since then, large electric motors with VFDs are replacing gas and steam turbines for driving large compressors. Considering both environmental and economic factors, high-speed electric motors with variable speed drives have shown advantage over gas turbines as a prime mover for natural gas compressor applications [11-12].

Where it is desirable to eliminate gearboxes and their associated accessory systems, high-speed machines have become an increasingly attractive design solution.

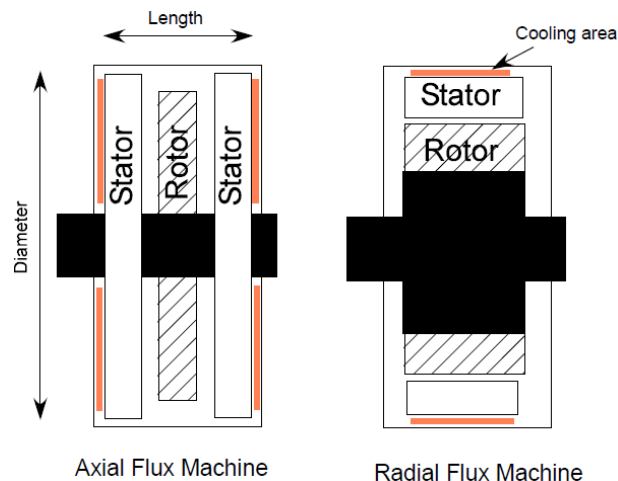

Fig. 4. Comparison of radial flux configuration with axial flux configuration [10]

High-speed brushless DC machines are considered for subsea, off-shore and ship-board applications due to the better power to weight ratio, smaller size, and higher efficiency compared to induction machines, [13-14]. High-speed operation allows the machines to be smaller than conventional machines in the same power rating which results in considerable higher power density than a conventional machine. Figure 5 shows the comparison of a conventional induction motor with gearbox with a high speed brushless DC motor [15].

### High speed electric motor plus variable frequency drive advantages over a Gas Turbine

As mentioned earlier, recently large compression systems are using mechanical prime movers such as gas turbines. In an industry where the engineers and operators have long experience of mechanical expertise and experience, high speed electric motors should have strong advantage in order to replace mechanical prime movers.

The benefits of using brushless DC motor and variable frequency drive are:

- Lower energy costs:  
Brushless DC motor and variable frequency

drive has higher efficiency than gas turbines, especially at part load.

- Reduced downtime:

Gas turbines require frequent maintenance while brushless DC motor and variable frequency drive requires very little maintenance. This yields lower maintenance expenses, more production and improved productivity.

- Accurate speed control and process control
- Zero CO<sub>2</sub> emissions and reduced noise.
- Brushless DC motor and variable frequency drive are not affected by temperature

By increasing inlet air temperature, gas turbines produce less power since the air density is reduced and less oxygen reaches the combustion chambers.

- Lower spare parts, maintenance and capital equipment cost.

Figure 6 shows a typical gas turbine driven compressor train [16]. Figure 7 shows a compressor driven by a high speed motor and variable frequency drive [16].

By using high speed electric motor and variable frequency drive to run large compressors, the starting current is controlled

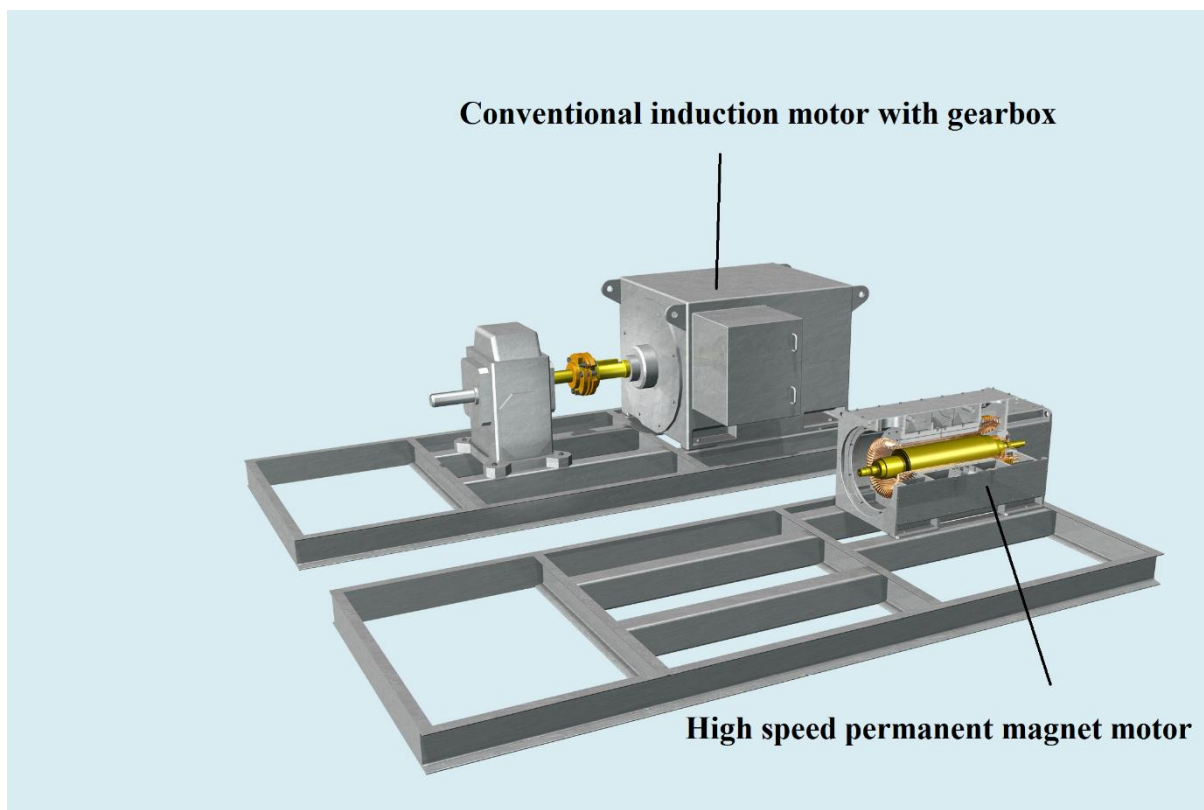

Fig. 5. Comparison of a conventional induction motor with gearbox with a high speed brushless DC motor [15]

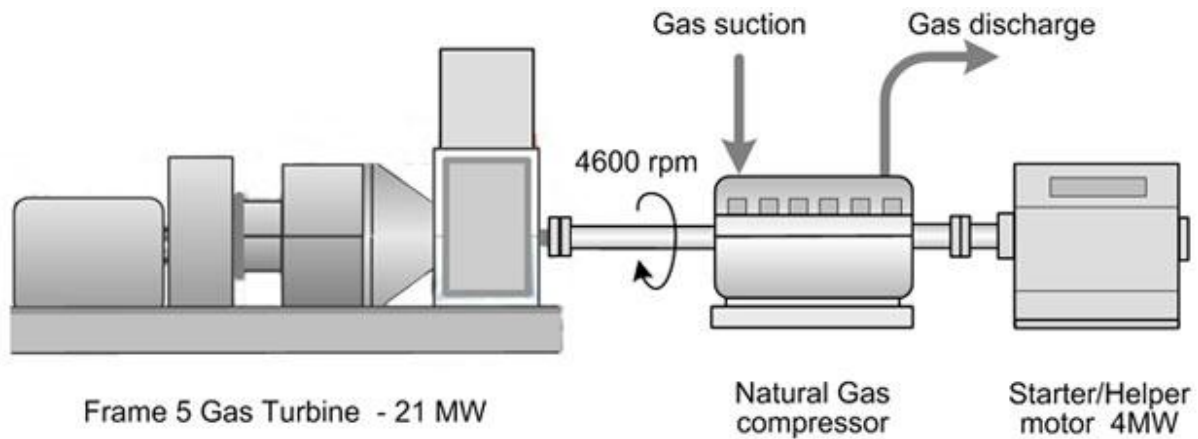

Fig. 6. A typical gas turbine driven compressor train [16]

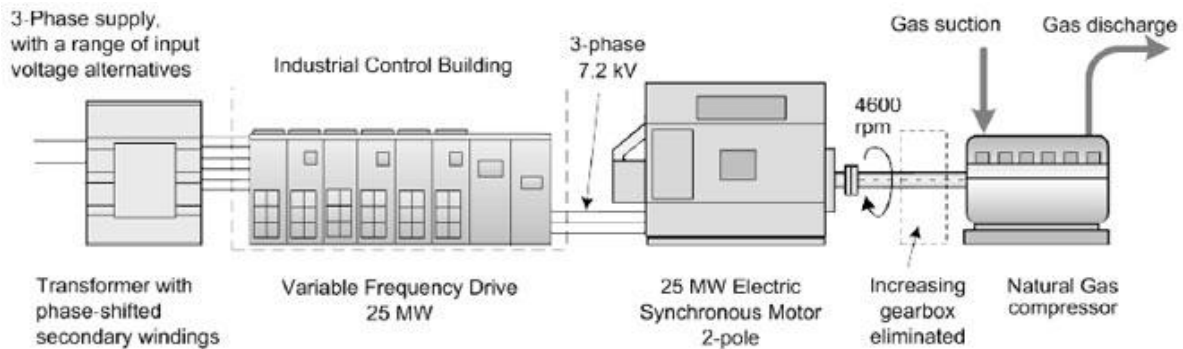

Fig. 7. A compressor driven by a high speed motor and variable frequency drive [16]

so that no large inrush occurs. Large inrush can result in overheating in the motor and a dip in the supply voltage. Limiting inrush will save considerable electrical charges. Typically a speed increasing gearbox is required for standard speed motors like 1500/1800 rpm or 3000/3600 rpm motors. By using a high speed electric motor and variable frequency drive the gearbox can be eliminated.

### Energy Consumption

The cost of fuel is the main operating expense of a plant. Figure 8 compares the efficiencies of five different scenarios to run a compression station. The higher the efficiency, the lower the fuel expense.

#### 2.1.2. Artificial lift and electric submersible motors

If the natural energy of the reservoir is not sufficient enough to push the oil to the surface from the oil well, alternative artificial methods will be used to increase pressure within the reservoir and push oil to the surface. This process of artificially pushing

oil to the well surface is called artificial lift. In fact, artificial lift is employed to recover most of the oil in the production well. Some wells have enough pressure to push the oil to rise to the surface without stimulation but most wells do not have this pressure naturally and require artificial lift.

Most wells require artificial lift from the beginning and even in those wells that initially have natural flow to the surface, that pressure depletes over time, and artificial lift is then required. In fact, artificial lift is generally performed on all wells at some time during their production life.

There are several methods to achieve artificial lift, one of the main categories of artificial lift include pumping systems. Electric submersible motors are used in conjunction with centrifugal pumps or Progressing Cavity Pumps (PCP) to increase the crude oil flow, from a production well. Obviously, the motor and pump must have small diameters to fit inside an oil well. Figure 9 shows a schematic view of Electric Submersible Pumping (ESP) system. Today, there are more than 130,000 ESP's installed globally, these ESP's account for more than 60% of global oil production [18].



### Electric Motor Driven Compressor

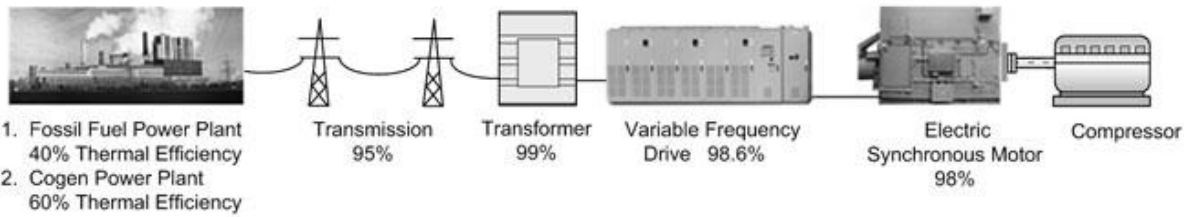

1. Drive, Transformer and Motor - Overall Thermal Efficiency =  $0.99 \times 0.986 \times 0.98 = 95\%$
2. Electric System with Standard Power Plant - Overall Thermal Efficiency =  $0.40 \times 0.95 \times 0.99 \times 0.986 \times 0.98 = 36\%$
3. Electric System with Cogen Power Plant - Overall Thermal Efficiency =  $0.60 \times 0.95 \times 0.99 \times 0.986 \times 0.98 = 55\%$

### Gas Turbine Driven Compressor

Efficiency depends on whether it is Industrial or Aeroderivative turbine

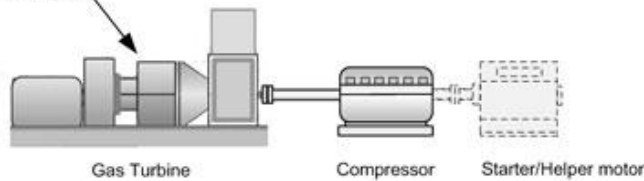

Example: Industrial Turbine, not including starter motor

4. Turbine System at Best Conditions [-40 Degree C] and full load Thermal Efficiency = 36%
5. Turbine System at High Temperature [+40 Degree C] and Part Load Thermal Efficiency = 19.4%

Fig. 8. Comparison of efficiencies for five different scenarios to run a compression station [16]

### A typical ESP installation

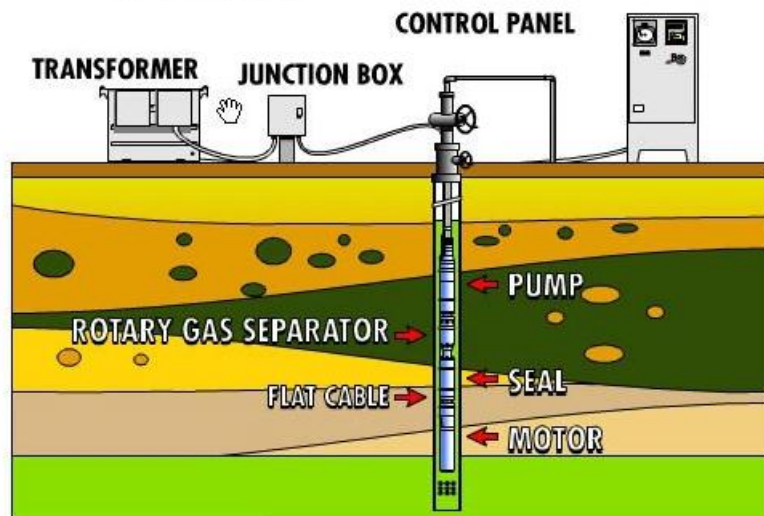

Fig. 9. Schematic view of an ESP system [17]

Since artificial lift systems should work continually during the well's life, electricity costs are significant and system efficiency is a major concern therefore, induction motors are less efficient than brushless DC motors been that they consume more power overall and cost more to maintain. Field tests measured input power and flow using the same pump for both induction motor and brushless DC motor, results on average, showed that the brushless DC motor used 20% less power than the induction motor [19].

2.2. Transportation  
2.2.1. Train applications

Brushless DC motor achieved higher efficiency than traditional induction motor due to the elimination of secondary loss. Current brushless DC motor technology for train applications boasts a high efficiency of 97%. As Figure 10 shows, brushless DC propulsion system achieves 39% energy saving for commercial trains compared to conventional systems [20-21].

Operators of railway systems are trying to make maintenance simple and cost effective. Due to the nature of its construction, the maintenance of conventional railway induction motor systems is time consuming. Replacing the conventional induction train motors with the brushless DC motors significantly decreases the maintenance costs [20].

For the traction of subway trains, demands to ensure low noise operation have been intensifying year by year. Using brushless DC

motors provide a more quiet performance than conventional induction metro motors.

2.2.2. Automotive applications

High power brushless DC motors are found in electric vehicles and hybrid vehicles. Cars are already using BLDC motors for windshield wipers, CD players, and power windows.

Electric car manufacturers often prefer brushless DC motors over other alternatives because the efficiency is higher, rotor cooling is simpler and they respond faster. The high-performance, small-diameter magnetic rotors reduce the inertia of the armature, allowing high acceleration rates, a reduction in rotational losses, and smoother servo characteristics. This optimal motor response also allows for more constant speeds, instant speed regulation and a more quiet drive system. Figure 11 shows a view of General Motor's 85 kW brushless DC electric motor used in 2014 Chevrolet Spark EV.

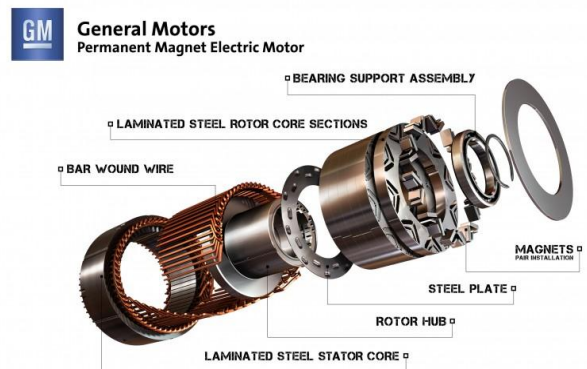

Fig. 11. General Motor's 85 kW brushless DC electric motor [22]

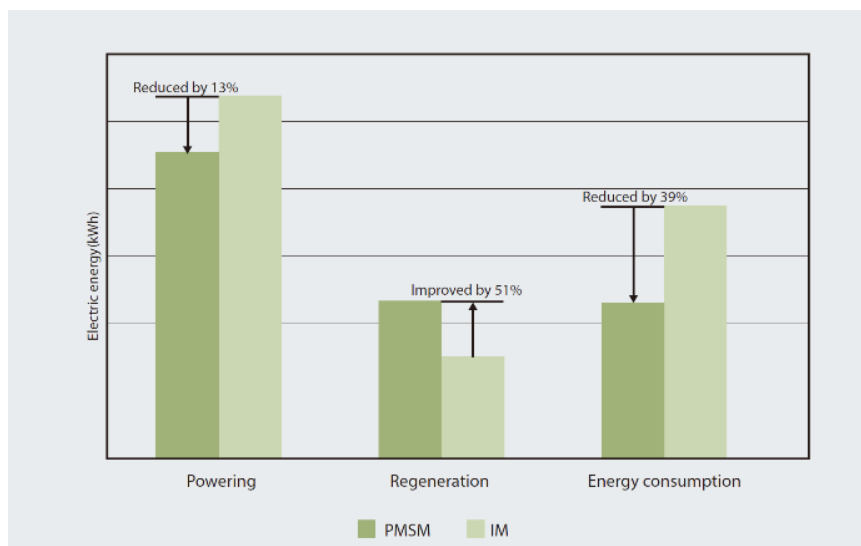

Fig. 10. Comparison between energy consumption of Permanent Magnet Synchronous Motors (PMSM) or brushless DC motors and Induction Motors (IM) for metro train application [20]



### 2.3. Home Appliances

In recent years, significant attention has been shown in developing highly efficient motor technologies and their applications. Figure 12 shows the electricity consumption in Japan [23].

As shown in Fig.11, electric motors consume 50% or more of the total electricity. The need for a power plant with an output capability as high as approximately 500 000 kWh can be eliminated by improving the efficiency of each electric motor by only 1%. Figure 13 shows the household electric power consumption in Japan [23]. Refrigerators and

air conditioners consume a total of 46% of the household electric power consumption. They require fans and compressors that usually need induction motors.

Recently a great percentage of manufacturers and consumers have migrated from the induction motors to the brushless DC synchronous motors because of their higher efficiency. Figure 14 shows the motor performance in the home appliance field.

As shown in Fig.14, most motors need variable speed operation and this is why variable speed brushless DC motors can save significant amount of energy.

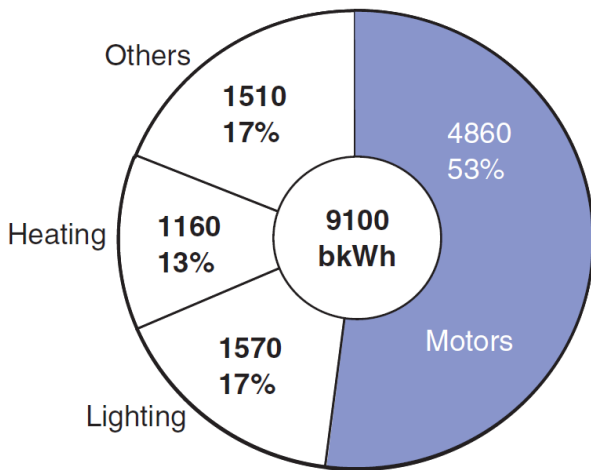

Fig. 12. Electricity consumption in Japan [23]

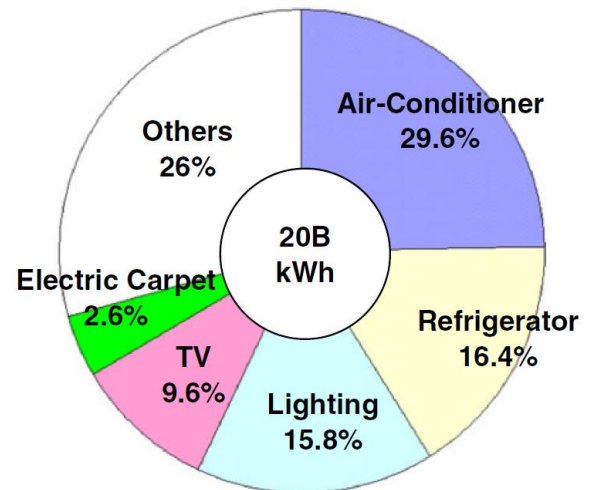

Fig. 13. Household power consumption in Japan [23]

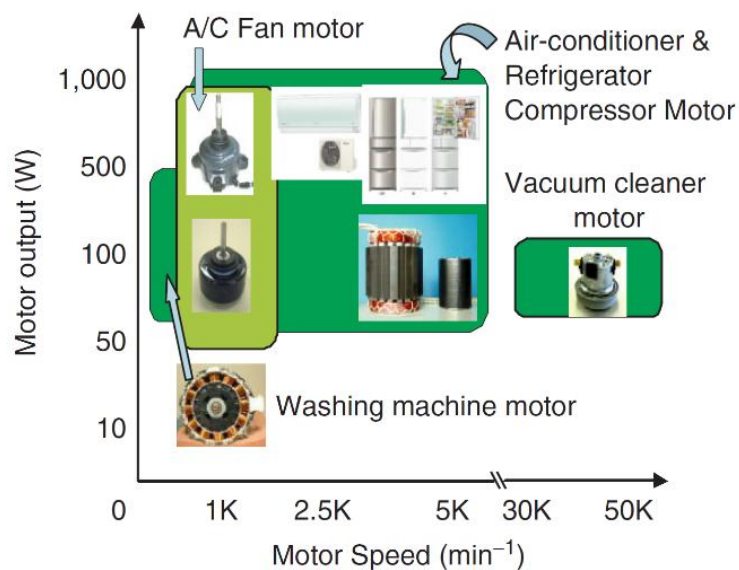

Fig. 14. Home appliances motor characteristic [23]

### 2.4. HVAC and refrigeration

As shown in Fig.15, residential and commercial sectors represent approximately 40% of the total energy consumed in US in 2013. Electric motors account for more than 25% of the energy consumption in both the residential and commercial sectors, therefore 10% of total energy consumed can be approximately attributed to electric motor driven systems in the residential and commercial sectors [24].

Figures 16 and 17 provide a breakdown of motor driven energy consumption by end users for the US commercial and residential sectors, respectively. Motor driven components used in ventilation, heating, air conditioning (HVAC) and refrigeration are

largest energy consumers in both the residential and commercial sectors. In the commercial sector, the refrigeration and HVAC categories together account for 93% of motor driven energy use.

In the residential sector, HVAC applications account for 63% of motor driven energy use, and refrigeration accounts for 28%.

Application of brushless DC motors in the HVAC and refrigeration industries is rapidly increasing due to reduction in power required to operate them versus a typical AC motor. In addition to higher efficiency, certain HVAC systems use brushless motors because the built-in microprocessor allows for better control over airflow, and serial communication.

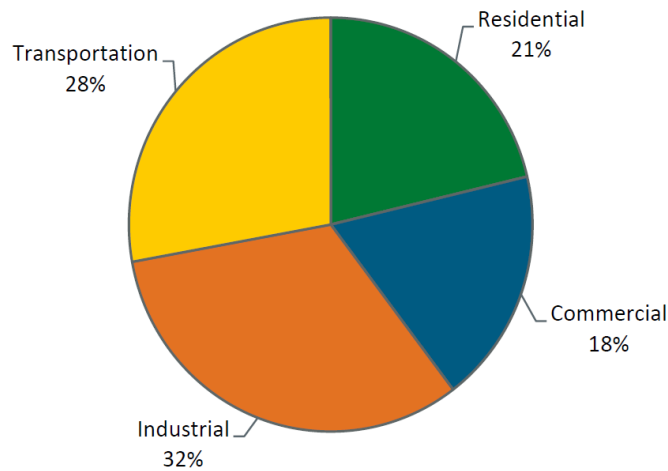

Fig. 15. 2013 energy consumption in US [24]

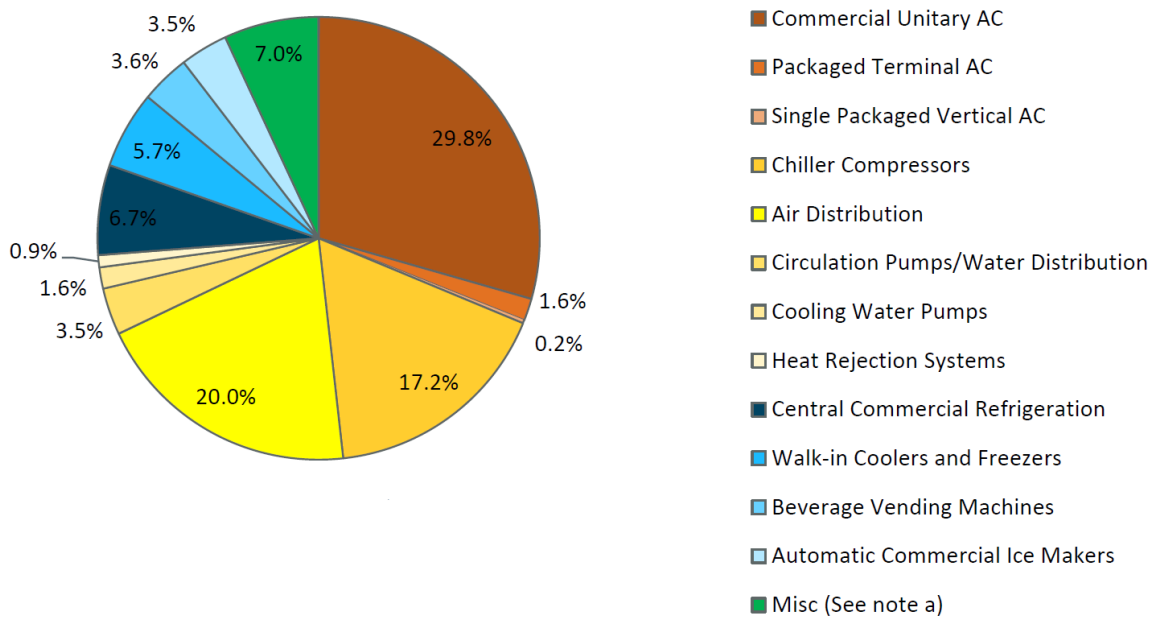

Fig. 16. US commercial sector electric motor energy consumption in 2013 [24]

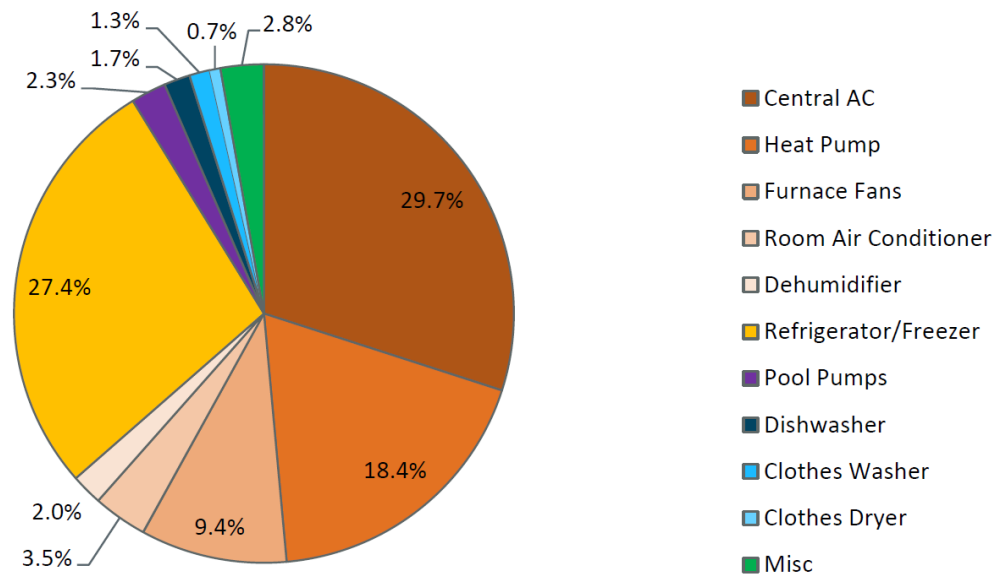

Fig. 17. US residential sector electric motor energy consumption in 2013 [24]

2.5. Marine propulsion

2.5.1. Ship applications

The transport section produces about 20% of the total amount of exhaust gases. The need for a novel and smarter propulsion approach is becoming more apparent as cost pressures mount and environmental regulations become more stringent. Variable speed three phase electrical drives are more frequently used for ship propulsion, especially for tourist boats. An essential advantage of electrical drives is their higher efficiency, low emission and increased maneuverability [25]. Figure 18 shows a typical electric motor arrangement for ship applications.

This is especially the case for multipurpose service vessels that operate primarily at partial load conditions. Using brushless DC motors and generators as key elements in advanced drive trains allows ship owners to take advantage of a more flexible, modular, efficient and lightweight propulsion system. The technology enables ships to lower their operational costs by optimizing fuel consumption through superior efficiency, reliability and design flexibility.

2.5.2. Submarine applications

Complete reliability and operational readiness of propulsion motors is critical for submarines.

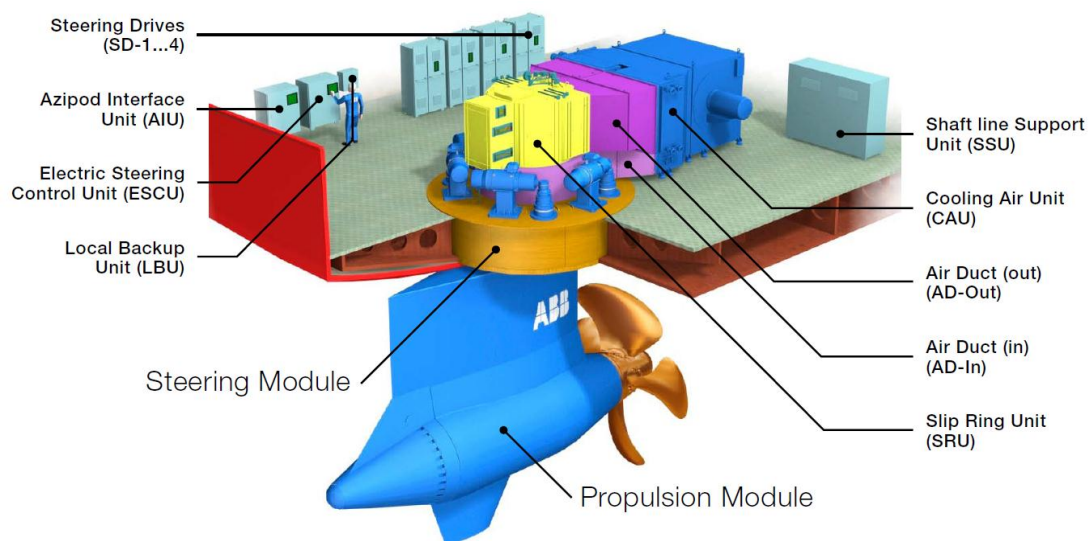

Fig. 18. Basic arrangement for ABB Azipod X series podded electric main propulsion and steering system [26]

A drive system that works efficiently with very low signatures is critical for long dives and it makes boat detection harder. With the use of brushless DC motor for submarines, these requirements can be accomplished. Although brushless DC motor is smaller and lighter than conventional propulsion solutions, it achieves much better efficiency at extremely low signatures. Figure 19 shows a view of a submarine brushless DC motor manufactured by Siemens.

## 2.6. Energy production

### 2.6.1. Micro turbine

The current direction toward distributed power generation has raised interest for different concepts of small scale power generation equipment in the 30 to 200 kW range [28-29].

High speed mini turbines and micro

turbines have a noticeable role in the Distributed Power Systems that provide electric power close to the user. Several types of high speed turbo generators manufactured by different companies are now available in the 30 to 90 kW range. These systems operate at speeds from 50000 to 120000 rpm.

The generator is directly coupled to the turbine shaft. This eliminates the need for a gearbox, helps reduce the size of the generator, and lowers the cost of the overall system. The output power is electronically processed and conditioned to provide constant voltage DC or multi-phase AC power at constant frequency. Figure 20 shows a schematic view of a micro turbine.

Due to high efficiency and power density, at the present time most generators used with micro-turbines are based on permanent magnet technology (brushless). Figure 21 shows a micro turbine with a brushless DC generator.



Fig. 19. Brushless DC submarine electric motor Permasyn [27]

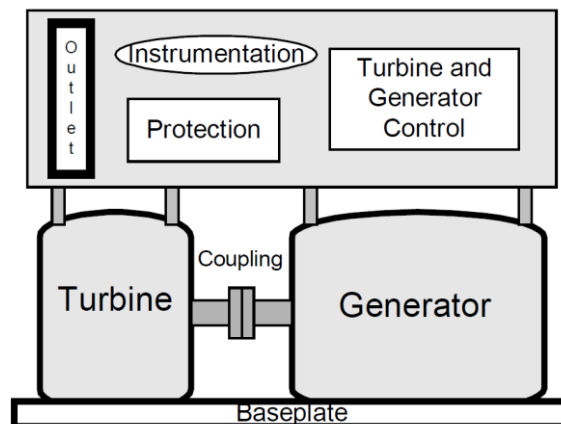

Fig. 20. Schematic view of a micro turbine [30]





Fig. 21. A high speed micro turbine with permanent magnet (brushless) generator [31]

2.6.2. Wind turbine

Permanent magnet generators (brushless) are the ideal solution for the wind industry. The wind turbine power system becomes more efficient, by adjusting the power and speed of the generator to that of the wind turbine. Employing a synchronous field permanent magnet generator, the permanent magnet direct drive configuration is gaining strong interest because it offers simplicity and potential reduction in size, weight, and cost compared to a drive train incorporating a wound-field generator rotor.

Gear speed increaser in conventional wind turbines is susceptible to significant accumulated fatigue torque loading, related reliability issues, and maintenance costs. In permanent magnet, direct drive wind turbines gearbox is eliminated.

Figure 22 shows comparison of a common configuration of a conventional geared wind turbine with a configuration of direct drive permanent magnet wind turbine. As shown in this figure,, elimination of gearbox in permanent magnet wind turbines yields a much simpler and lighter configuration.

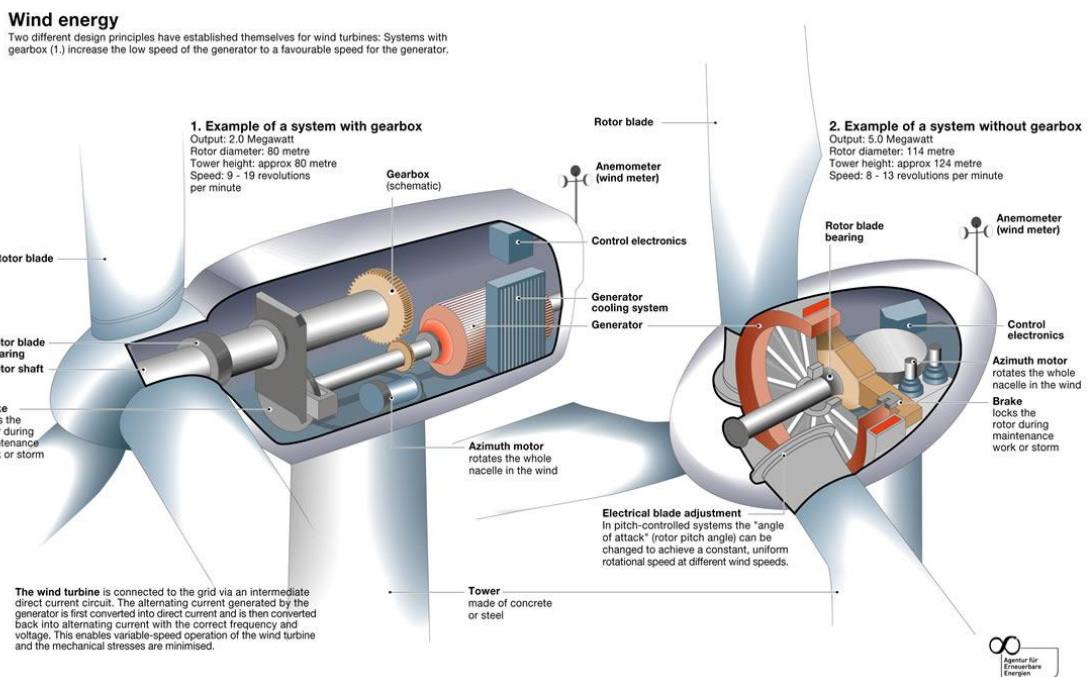

Fig. 22. Comparison of a geared wind turbine with a permanent magnet direct drive (brushless) wind turbine configuration [32]



### 3. Conclusions

This review paper illustrates several examples of recent applications of brushless DC machines in the oil & gas, transportation, home appliance, HVAC and refrigeration, marine propulsion and energy production areas and the potential of energy saving for these applications was discussed.

Electric motor systems have massive energy efficiency potential. Many of the electric motors have lifetimes of up to 20 years and choosing energy efficient motors yields energy saving costs several fold the initial motor price. In developed countries with sometimes several decades old technological production structure, energy efficiency improvements such as replacing old inefficient motors with new efficient ones are often expensive, because it requires substantial system changes or even interruption of the production process. But developing countries with high growth rates and a fast growing industry can benefit from energy efficient motor systems.

For almost all the types of equipment in the residential, commercial and industrial sectors, the market is transitioning to variable speed brushless DC machine technology for their higher efficiency. Brushless DC machines are becoming increasingly cost-effective when considering simple payback period. They also offer other non-energy benefits such as reduced noise and the ability to reach higher rotational speeds.

### References

- [1] WaIde, Paul, Brunner, Conrad et al.: Energy-Efficiency Policy Opportunities for Electric Motor-Driven Systems, OECD Publishing, (2011).
- [2] De Almeida *et al.*, Improving the Penetration of Energy-Efficient Motors and Drives, European Commission SAVE Study, Institute of Systems and Robotics, University of Coimbra, Portugal, (2008).
- [3][http://rjwsciencestm.com/Physics\\_Notes/U4\\_Motor.html](http://rjwsciencestm.com/Physics_Notes/U4_Motor.html)
- [4] <http://www.electrical4u.com/permanent-magnet-dc-motor-or-pmdc-motor/>
- [5][http://en.wikipedia.org/wiki/Brushed\\_DC\\_electric\\_motor](http://en.wikipedia.org/wiki/Brushed_DC_electric_motor)
- [6] Wilson T.G., Trickey P.H., D.C. Machine with Solid State Commutation, AIEE paper I. CP62-1372, October 7, (1962).
- [7] Kenjlo T., Nagamori S., Permanent-Magnet and Brushless DC Motors, Clarendon Press(1985)
- [8] Brushless Permanent-Magnet Motor Design, DC Hanselman , McGraw-Hill New York,(1994)
- [9] Permanent Magnet Motor Technology: Design and Applications, JF Gieras – (2002) CRC press
- [10]<http://endless-sphere.com/forums/viewtopic.php?f=30&t=18919&start=0>
- [11] Wood B. M., Olsen C. L., Hartzo G. D., Rama J. C., Szenasi F. R., Development of an 11 000-r/min 3500-hp Induction Motor and Adjustable-Speed Drive for Refinery Service, IEEE Transactions on Industry Applications, Vol.33 No.3, May/Jun (1997) 815-825.
- [12] LaGrone S., Griggs M., Bressani M., Application of a 5500 RPM High Speed Induction Motor and Drive in a 7000 HP Natural Gas Compressor Installation, IEEE PCIC Conference Record, (1992) 141-146.
- [13] Weeber K., Stephens C., Vandam J., Gravame A., Yagielski J., Messervey D., High-Speed Permanent Magnet Motors for Oil & Gas Industry, Proceedings of GT 2007 ASME Turbo Expo 2007: Power for Land and Air, May 14-17, (2007) Montreal, Canada.
- [14] Shade N., New Compression and Power Application, Compressor Technical Two, March (2008) 20-26.
- [15] [www.fmctechologies.com](http://www.fmctechologies.com)
- [16] <http://www.vfds.org/vfd-for-compressor-in-oil-and-gas-industry-569737.html>
- [17][http://i01.i.aliimg.com/img/pb/607/593/462/462593607\\_870.jpg](http://i01.i.aliimg.com/img/pb/607/593/462/462593607_870.jpg)
- [18][http://www.ge-energy.com/products\\_and\\_services/products/electric\\_submersible\\_pumping\\_systems/](http://www.ge-energy.com/products_and_services/products/electric_submersible_pumping_systems/)
- [19] Brinner T., McCoy R., Kopecky T., Induction Vs. Permanent Magnet Motors for Electric Submersible Pumps Field and Laboratory Comparisons, Petroleum and Chemical Industry Technical Conference (PCIC), (2012) Record of Conference Papers Industry Applications Society 59th Annual IEEE, (2012)1-9.
- [20] Permanent Magnet Synchronous Motor for Traction Systems, [http://www.toshiba.co.jp/sis/railwaysystem/en/products/catalog/pdf/permanent\\_magnet\\_synchronous\\_motor\\_for\\_propulsion\\_systems.pdf](http://www.toshiba.co.jp/sis/railwaysystem/en/products/catalog/pdf/permanent_magnet_synchronous_motor_for_propulsion_systems.pdf)
- [21] Tasaka Y., PMSM Propulsion System

- for Tokyo Metro, Electrical Systems for Aircraft, Railway and Ship Propulsion (ESARS), (2012) 1-6.
- [22] <http://www.gizmag.com/gm-85-kw-ev-motor/20329/>
- [23] Honda, Yukio, Takeda, Yoji, Technical Evolution of Permanent Magnet Synchronous Motors for Home Appliances, IEEJ Transactions on Electrical and Electronic Engineering, Vol.2, No.2,(2007) 118-124, publisher Wiley Online Library
- [24] Rosenquist, Greg, McNeil, Michael, Iyer, Maithili, Meyers, Stephen, McMahon, James, Energy Efficiency Standards for Equipment: Additional Opportunities in the Residential and Commercial Sectors, Journal Energy Policy, Vol.34, No.17, (2006) 3257 -3267, Publisher Elsevier
- [25] Rudolf M., Permanent Magnet Synchronous Motor for Passenger Ship Propulsion
- [26] Azipod Product Platform Selection Guide, ABB Marine, (2010).
- [27] SINAVY Permasyn – Small, Reliable, and Difficult to Trace, Siemens Marine & Shipbuilding, (2013).
- [28] Aglen, O. A High Speed Generator for Microturbines, International Conference on Electrical Engineering And Technology ICEET01, Dares Salaam, Tanzania, (2001).
- [29] Consterdine E., Hesmondhalgh D.E., Reece A.B.J., Tipping D., An Assessment of the Power Available from a Permanent Magnet Synchronous Motor which Rotates at 500,000 rpm, International Conference on Electrical Machines ICEM'92, Manchester, U.K., (1992) 746-750.
- [30] Vaidya J., Gregory E., Advanced Electric Generator & Control for High Speed Micro/Mini Turbine Based Power Systems
- [31] <http://www.mechsys.cz/>
- [32] <http://www.greencollarjobtraining-free.com/600/601.htm>